

THIS DRAWING IS UNPUBLISHED.

RELEASED FOR PUBLICATION

ALL RIGHTS RESERVED.

© COPYRIGHT - By -

REVISIONS

P	LTR	DESCRIPTION	DATE	DWN	APVD
	C2	REVISED	ECR-18-009736	22JUN2018	TS HY

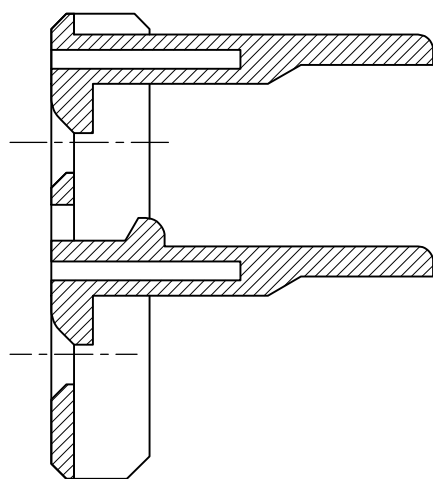
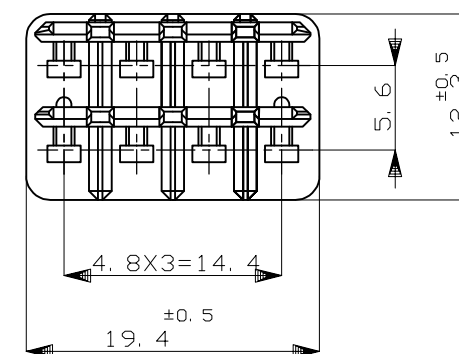
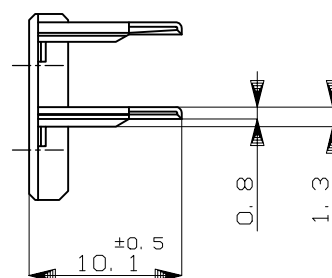
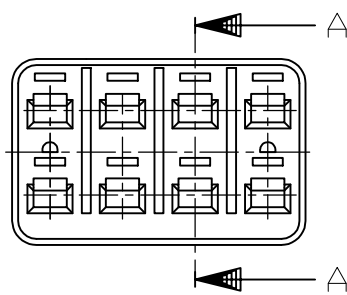
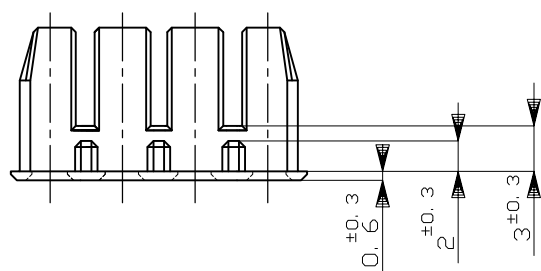

SECTION
断面 A-A
(尺度 5:1)

- 1. 本品は、プラグハウジング型番 174982及び 2822393に装着される
- 2. 製品規格；108-5262

- 1. TO BE MATED WITH PLUG HOUSING PART NUMBER 174982 AND 2822393
- 2. PRODUCT SPECIFICATION；108-5262

HB	自然色 (NATURAL)	1-174983-1
V-2	黄 (YELLOW)	174983-7
使用材料難燃グレード (FLAMMABILITY OF MATERIAL)	色 (COLOR)	型番 (PART NUMBER)

GENERAL TOLERANCE

0 < * ≤ 10	: ±0.2
10 < * ≤ 30	: ±0.25
30 < * ≤ 100	: ±0.3
ANGLES	: ±3°

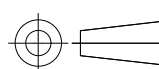
THIS DRAWING IS A CONTROLLED DOCUMENT.		DWN K.ODA 12/18'87	 TE Connectivity Ltd.														
DIMENSIONS: mm		CHK M.NOGUCHI 12/18'87															
TOLERANCES UNLESS OTHERWISE SPECIFIED:		APVD M.NOGUCHI 11/4'88	NAME 8P. ECONOSEAL J-MARKII+ CONNECTOR DOUBLE LOCK PLATE FOR PLUG HOUSING														
		PRODUCT SPEC SEE NOTE 2	SIZE A3														
MATERIAL PBT		FINISH -	APPLICATION SPEC -	CAGE CODE 00779	DRAWING NO C-174983												
<table border="1"> <tr> <td>0 PLC</td> <td>± -</td> </tr> <tr> <td>1 PLC</td> <td>± -</td> </tr> <tr> <td>2 PLC</td> <td>± -</td> </tr> <tr> <td>3 PLC</td> <td>± -</td> </tr> <tr> <td>4 PLC</td> <td>± -</td> </tr> <tr> <td>ANGLES</td> <td>± -</td> </tr> </table>		0 PLC	± -	1 PLC	± -	2 PLC	± -	3 PLC	± -	4 PLC	± -	ANGLES	± -	WEIGHT 0.6 g	RESTRICTED TO -	SCALE 2:1	SHEET 1 OF 1
0 PLC	± -																
1 PLC	± -																
2 PLC	± -																
3 PLC	± -																
4 PLC	± -																
ANGLES	± -																
CUSTOMER DRAWING			REV C2														